

FM STEREO TUNER

T-110

SERVICE MANUAL

CIRCUIT DESCRIPTION

In the T-110 there are 4 basic function blocks: these being the Front End, the I.F. strip together with the audio recovery circuit and the Stereo decoder section, plus of course the Power supply and switches.

The Front End

This is the most important section of the tuner as it decides most of the basic characteristics. So the radio signals are picked up by the antenna and enter the tuner at the antenna terminals. They go through an impedance matching network known as a balun transformer to be at a suitable impedance for the Front End proper.

This Front End has been designed bearing in mind the many problems of spurious rejection and cross modulation (cross modulation occurs when a powerful transmitter close by of unrelated frequency saturates the front end and generates many harmonics which often are then related to the desired frequency and block the tuner to give poor performance). Therefore we use MOS FET's which are known to have very good linearity and can handle strong signals very well in the R.F. amplifier and mixer stages, together with 3 tuned R.F. stages to provide the required selectivity and reduce various spurious radiation to manageable amounts.

The local oscillator in the Front End must be very carefully designed as its output is mixed with the desired signals to produce the I.F. output. So it must also have a very pure fundamental output because harmonics are not at all desirable, therefore its coupling circuitry to the mixer is very important to ensure very high isolation from the incoming signals.

Total drift is less than 10KHz at any time after switch on and at reasonable ambient temperatures (10°C - 40°C). This Front End has a total of five tuning elements as the tuning capacitor.

IF Amplifying & Detecting Circuitry

This circuitry offers very important role for various characteristics such as selectivity, distortion, separation, capture ratio or AM suppression ratio, all of which are to draw the excellent performance of the multiplex (MPX) circuitry where the composite signal is de-modulated into the stereophonic signal.

Low distortion is the most excellent point of the T-110, which entirely depends on the design of the element for the selectivity. On detecting the FM radio wave, no distortion will appear if the phase characteristic is perfectly linear against the frequency shift.

However, in actual, it is necessary to provide selectivity, therefore some phase distortion is inevitable. The element for selectivity adopted in the T-110 has been designed with great stress on this phase characteristic. Thus provided is the linear-phase LC block filter of 4-elements in which the group-delay time is kept within 0.5u sec. ranging over 300KHz. Here two linear-phase LC block filters and the selected linear-phase ceramic filter are coupled to reduce the distortion by ensuring selectivity and keeping the group-delay time down to a minimum within the range.

The IF amplifying element has realized excellent limiter characteristic by adopting IC's of high integration for the simple differential amplifier, the three-stage differential amp of constant current drive etc.

Multiplex Circuitry

The multiplex (MPX) circuitry de-modulates the left and the right signals of the stereophonic broadcasting. A selected IC of Phase Locked Loop type is adopted according to the philosophy of LUX.

The conventional MPX circuitry of discrete type has to produce the 38KHz signal for the switching operation, by repeating the pattern that the pilot signal included in the composite signal is tuned by the LC type tuning circuitry and then amplify the signal. But Once the phase of this 38KHz signal drifts, the separation and distortion will deteriorate. This has been solved by temperature compensation provided in the tuning circuitry.

As for the PLL IC, the Variable Controlled Oscillator (V.C.O.) is provided in the IC to produce the 38KHz signal for the switching, to constitute the phase locked loop which automatically controls these two phases of the V.C.O. and the pilot signal to be the same by comparing the oscillation frequency and the frequency of the pilot signal. Therefore even if the V.C.O. drifts by the fluctuation of the ambient temperature, separation and distortion will not be deteriorated since the phase is automatically locked to the phase of the pilot signal.

Thus the PLL IC has excellent performance theoretically. Incidentally various types have been developed of late by the semi-conductor manufacturers. But unfortunately these did not better the MPX circuitry due to the distortion problem. However, recently, a reliable dual-in-line type with low distortion has been developed, enabling its adoption to the quality tuner.

Low-pass Filter

This filter removes the carrier leakage at the de-modulation into stereo signal. And careful attention has been paid to the delay-time for the audio frequency range. Also the residual carrier leakage is kept down to low limits.

Audio Output Amplifying Circuitry

A differential amplifier of (+) (-) two power supply is adopted to attain ultra low-distortion amplification of the audio signal which is de-modulated by these front end, IF circuitry and MPX circuitry. Sufficient negative feedback ensures a low output impedance.

The conventional muting circuitry of simple structure controls the circuitry by the collector-wave of Q214. As you can see from the drawing, the collector-wave is the control signal of wide range, therefore the muting operation starts even at the terribly distorted point, that is, detected at the ends of the S-curve of the output wave from the discriminator.

To eliminate the above weak point, each collector output of Q214 and Q215 is fed to the "AND" circuitry, whose muting width controls the muting circuitry. Therefore the muting operation will be started in the distortion-free condition.

Further thanks to the circuit design, the determined width of the muting threshold will remain stable from weak signals to strong ones, therefore stable muting-feeling is realized. DC output voltage will never appear due to adoption of the differential IC of (+) (-) 2 power supply at the final output stage, which is switched ON-OFF by a reed relay. Thus the pop-up noise is perfectly eliminated.

Time Delay Muting Circuitry

Any switch on thumps caused not only during the operation but just before putting into operation or right after the termination of operation are designed to be removed. This circuitry, after all, removes the switch on noises at the time of the ON-OFF operation of the power switch, the provision of which has not been adopted by the conventional tuners.

When the power switch is turned on, a time-constant circuitry composed of a resistor and a capacitor controls the transistor for relay-drive, which will keep controlling until each circuitry is put into stable operational condition. When it becomes stable, this circuitry is released to allow sound reproduction. When the power is off, the remaining electricity is discharged quite quickly by the small time-constant circuitry composed of capacitors and transistors to make the muting circuitry

operate. Thus undesired thump noises are removed by the time-delay muting circuitry both at the "ON" and "OFF" operation of the power switch.

Dial Pointer/Winker

The dial scale consists of slender slits, and the illuminated dial pointer moves across just behind these slits, which is designed to blink to inform that the receiving signal is too weak for the reproduction when the signal is under a certain muting level, and that the tuning is incorrect in case it is at the inter-station receiving state when the FM muting switch is at the "ON" position. The dial pointer is made to blink by the multi-vibration circuitry which is controlled by the "AND" output of the FM muting circuitry. When the FM muting switch is set at the "OFF" position to receive weak signals below the muting level, the dial pointer will not blink.

Constant Voltage Power Supply Circuitry

This is provided to ensure stable tuner operation against the fluctuation of the AC mains voltage or the fluctuation of the DC supply voltage caused by the various circuit operations in the tuner. For the constant voltage circuitry, both (+) and (-) power supply system is provided. The former employs real constant voltage power supply circuit made by three transistors and zener diodes since it accepts rather heavy load, while the latter by zener diode only due to its light load. Thus stable operation is assured against the fluctuation of the AC mains voltage in the range of $\pm 10\%$.

T-110 ALIGNMENT PROCEDURE

The alignment procedure described in each chart may be performed independently, without affecting the others. Warm up the signal generators for at least 15 minutes to make certain if they are stabilized at their operating temperature particularly generators containing vacuum tubes. Consult the instruction manual supplied with the particular test instrument for specific information concerning connection and operation. The test equipment listed here is intended only as a guide, but alternate instruments should be of similar quality.

The following instruments are required for a complete alignment of the tuner.

1. Measurement instruments and tools

Signal source	1) FM signal generator (FMSG)	Output indicator	4) Oscilloscope (CRO)
	2) FM stereo modulator (MPXSG)		5) Distortion Meter (HDM)
	3) Audio oscillator (AFO)		6) AC volt meter (ACVTVM)
			7) DC volt meter (DCVTVM)
		Tools	8) Hex head alignment tool
			9) Thin plastic shaft alignment tool

2. General alignment conditions

- 1) The normal test voltage is within 10% of what is indicated on the tuner with less than 2% harmonic distortion.
- 2) Unless otherwise specified, the normal ambient temperature is 15°C - 25°C and humidity 55 - 75%. But as far as correct judgement is ensured 5 - 35°C, 45 - 85% is allowable.

Step	Signal Source Connected to	Set Signal to	Set Radio Dial to	Output Indicator Connected to	Adjust	Adjust for
13	Connect FM5G to the antenna terminal (300-ohm) through matching network	88MHz at mono, 1KHz, 30% modulation Output level 6uV	88MHz	Oscilloscope Distortion meter ACVTVM output terminals	LA	Maximum swing of signal meter
14					LR1	
15				LR2		
16				LR3		
17			108MHz at mono, 1KHz, 30% modulation Output level 6uV	108MHz	TCA	
18					TCR1	
19				TCR2		
20				TCR3		
21		98MHz at mono, 1KHz, 30% modulation Output level 6uV	98MHz		VR201	Adjust the swing of signal meter so as to indicate 50% swing of full scale
22	Set the muting switch at the "muting on" function					
23	Connect FM5G to the antenna terminal (300-ohm) through matching network	98MHz at mono, 1KHz, 30% modulation Output level 5uV	98MHz	Oscilloscope Distortion meter ACVTVM Output terminals	VR202	Fix VR202 at the point where output signals appear
24						
25	Set the muting switch at the "muting off" function					
26	Connect FM5G to the antenna terminal (300-ohm) through matching network	Reduce the output level to zero (interstation receiving condition)	Quiet point on band near 98 MHz	Oscilloscope Distortion meter ACVTVM Output terminals	T201 top core	Center indication of tuning meter
27						
28	Identify the minimum distortion at "0" point of tuning meter and the meter show "0" at interstation state.					

Step	Signal Source Connected to	Set Signal to	Set Radio Dial to	Output Indicator Connected to	Adjust	Adjust for
29	Connect FMSSG to the antenna terminal (300-ohm) through matching network	98MHz at 19KHz, 10% (L-R) 400Hz, 45% or 90% Output level 1mV	98MHz	Oscilloscope Distortion meter ACTVM	VR204	To obtain peak of output voltage. (This adjustment relative to stereo distortion)
30		98MHz at 19KHz, 10% R-ch, 1KHz, 90% Output level 1mV		Output terminal	VR205	To minimize the cross-talk to L-ch.
31		98MHz at 19KHz, 10% L-ch, 1KHz, 90% Output level 1mV				The cross-talk to R-ch should be nearly same with the cross-talk of step No.30.
32					Frontend LFT top and bottom core	Minimum distortion OBSERVE---within 3/4 turn

SEMICONDUCTOR REFERENCE CHART

Transistors ($T_a = 25^\circ\text{C}$)

Type	MAX. RATING			CHARACTERISTICS						
	Pt W	Vce V	Ic mA	hfe				fT MHz		
				min	max	Ic mA	Vce V	typ	Ic mA	Vce
2SC1647R	0.25	40	30	180	390	0.5	3	250	10	5
2SC735Y	0.30	30	400	120	240	100	1	300	50	5
2SC1674L	0.25	20	20	60	120	1	6	600	1	6
2SD235D/Y	1.50	35	3000	40	240	500	5	1	500	6
2SC1641R	0.30	32	150	180	390	10	3	250	20	5
2SC385A	0.20	15	20	20		8	3	600		
2SA823R	0.25	-40	-30	180	390	-1	-6	200	-10	-5

Field Effect Transistor (MOS), ($T_a = 25^\circ\text{C}$)

Type	MAX. RATING			CHARACTERISTICS						
	Pt mW	Vds V	Id mA	Idss mA			Crss pF		gfs	
				min	max	Vds V	max	Vds V	typ	Idss mA
3SK 40	250	20	25	4	25	10	0.05	15	10	5
3SK 45	330	-0.2 + 22	35	4	32	15	0.02	15	14	10

Field Effect Transistor (Junction), ($T_a = 25^\circ\text{C}$)

Type	MAX. RATING			CHARACTERISTICS						
	Pt mW	Vgds V	Ig mA	Idss mA			Ciss pF		gm	
				min	max	Vds V	max	Vds V	min	Vds
2SK 30-0	100	-50	10	0.6	1.4	10	8.2	0	1.5	10

Diodes ($T_a = 25^\circ\text{C}$)

Type	MAX. RATING			CHARACTERISTICS			
	IF A	Vr V	Surge A	If		Ir	
				mA	Vf V	uA	Vr V
1K188FM-1	0.05	-35	0.5	0.004	0.1	-75	-10
KE265	0.03			0.003	1.31		
1S1554V	0.10	-50	1	100	1.0	0.5	-50
SIRBA10	1	-100	30	500	1.05	-10	-100

Voltage-reference Diode

Type	MAX. RATING		CHARACTERISTICS					
	P mW	at $T_a, ^\circ\text{C}$	Vz V	Iz		Iz		Is uA
				mA	ohm	mA	Vs V	
WZ071	500	25	7.1	10	10	10	1	3
WZ120	500	25	12	5	15	5	1	10

INTEGRATED CIRCUIT SPECIFIC CHART

TA7061AP

MAXIMUM LIMITS OF DEVICE

	Symbol	Rating	Unit
Max. Vcc	Vcc	15	V
Input voltage (terminals 6 - 7)	VI	± 3	V
Max. dissipation	PD	300	mW
Operating temperature (vcc = 7.5V)	Topr	-30 - 75	°C
Storage temperature	Tstg	-55 - 125	°C

ELECTRICAL SPECIFICATION ($i_c = 25^\circ\text{C}$)

	Symbol	Condition of measurement	Min.	Tpy.	Max.	Unit
Current vs supply Vcc	Icc	Vcc = 6.0V (Vcc = 7.5V)	(7)	11(8.5)	13	mA
Gain (dB)	Gp	Vcc = 7.5V, f = 10.7KHz	66	69	72	dB
Input impedance	ri	Vcc = 7.5V, f = 10.7KHz		5		Kohm
Input capacitance	ci			6		pF
Output impedance	ro	Vcc = 7.5V, f = 10.7MHz		10		Kohm
Output capacitance	Co			5		pF
Input voltage for full limiting	VI(lim)	Vcc = 7.5V, RL = 1Kohm		600		uV

EQUIVALENT CIRCUIT

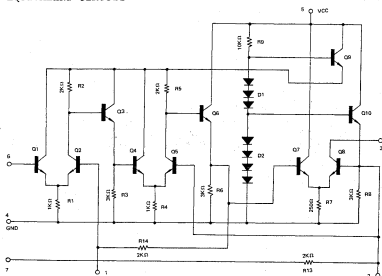

PIN CONNECTION

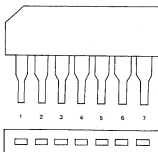

MAXIMUM LIMITS OF DEVICE

	Rating	Unit
Supply Voltage	+ 18	V
Power Dissipation	250	mW
Differential Input Voltage	+ 5	V
Input Voltage	+ 10	V
Output Short-Circuit Duration (Ta = 25°C)	5	sec
Storage Temperature Range	-65 - 150	°C
Operating Temperature Range	0 - 70	°C

ELECTRICAL SPECIFICATION (Ta = 25°C, Vcc = 12V)

PARAMETER	CONDITIONS	MIN	TYP	MAX	UNIT
Power Consumption	ein = 0		71	96	mW
Quiescent Output Current	ein = 0	1.5	2.5	3.3	mA
Peak-to-peak Output Current	ein = 400mV rms, f = 10.7KHz	3.0	5.0		mA
Output Saturation Voltage				1.7	V
Forward Transadmittance	ein = 10mV rms, f ≤ 10.7MHz	24.0	33.0		mmho
Reverse Transadmittance	ein = 10mV rms, f ≤ 10.7MHz		0.002		mmho
Input Conductance	ein = <10mV rms, f ≤ 10.7MHz		0.35	1.0	mmho
Input Capacitance	ein = <10mV rms, f ≤ 10.7MHz		9.0	12.5	pF
Output Capacitance	f ≤ 10.7MHz		2.6	4.0	pF
Output Conductance	f ≤ 10.7MHz		0.03	0.05	mmho
Noise Figure	Rs = 500-ohm, f = 10.7MHz Rs = 500-ohm, f = 100MHz		6.0 8.0		dB dB
Maximum Stable Gain	f = 100MHz		28.0		dB

EQUIVALENT CIRCUIT

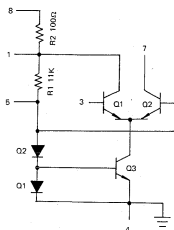

PIN CONNECTION (Top View)

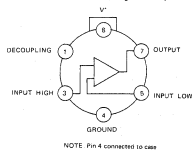

LA3350SS

ELECTRICAL CHARACTERISTICS

(Ta = 25°C, Vcc = 12V, RL = 3.3Kohms, Input level = 100mV, f = 1KHz, L + R = 90%, Pilot = 10%)

LA3350SS	Symbol	Test Conditions	Min	Typ	Max	Unit
No signal current	Icco		10	16	25	mA
Input impedance	Ri		15	20	26	K-ohm
Channel separation	Sep	Vi = 150mV	40	-	-	dB
Stereo distortion	ST. THD	Vi = 150mV L,R	-	0.05	-	%
Mono distortion	MONO. THD	Vi = 150mV Mono	-	0.05	-	%
Output level	Vo	Vin = 100mV	77	100	122	mV
Channel balance	Ba		-	0.5	1.0	dB
Sensitivity of Stereo indicator lamp	VL		52	-	100	mV
Hysterisis	hy		-	-	6	dB
Capture range	CR	Pilot = 10mV	+1	-	-	%
Output noise level	Vno	At test circuit	-	-	30	mV
SCA rejection	SCA Rej	L + R = 80%, Pilot = 10% SCA = 10%	-	80	-	dB

ABSOLUTE MAXIMUM RATING (Ta = 25°C)

LA3350SS	Symbol	Rating	Unit
Supply voltage, max	Vcc max	6 - 7	18
		1 - 7	16
Lamp driver current, max	IL	100	mA
Storage temperature	Tstg	-40 ~ +125	°C
Operating temperature	Topg	-20 ~ +70	°C
Device dissipation, max	Pd max	490	mW

FUNCTIONAL BLOCK DIAGRAM

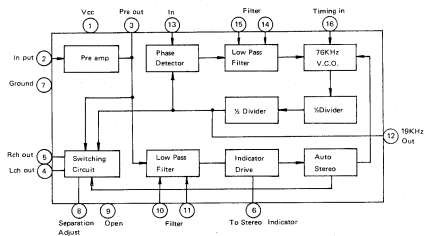

PIN CONNECTION (Top View)

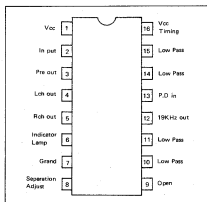

ABSOLUTE MAXIMUM RATING ($T_a = 25^\circ\text{C}$)

	Symbol	RATING	UNIT
Max. supply voltage	Vcc	15	V
Input voltage	Vin	+3.0	V
Max. dissipation	Pd	300	mW
Operating temperature	Topt	-20 - +75	°C
Storage temperature	Tstg	-40 - +125	°C

EQUIVALENT CIRCUIT

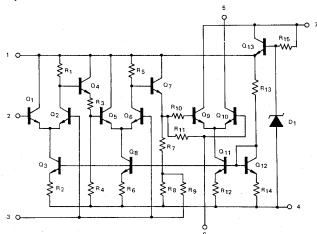
ELECTRICAL CHARACTERISTICS ($T_a = 25^\circ\text{C}$, $V_{cc} = 10\text{V}$)

	Symbol	Condition of measurement	MIN.	TYP.	MAX.	UNIT
Current vs supply Vcc	Icc	at zero signal	8.0	12.5	17.0	mA
Output collector current	Iout		0.9	1.6	2.3	mA
Stabilized voltage	V1	Terminal 1	4.4	5.1	5.8	V
Voltage gain	Av	$f=10.7\text{MHz}$, $R_G=50\text{-ohm}$ $R_L=1\text{Kohm}$, $v_i=40\text{dB}$	60	66	72	dB
Input impedance	ri	$f = 10.7\text{MHz}$		10		Kohm
Input capacitance	ci	$f = 10.7\text{MHz}$		5		pF
Output impedance	ro	$f = 10.7\text{MHz}$		30		Kohm
Output capacitance	Co	$f = 10.7\text{MHz}$		3		pF

TA 7136P

MAXIMUM LIMITS OF DEVICE ($T_a = 25^\circ\text{C}$)

	Symbol	Rating	Unit
MAX. Vcc	Vcc	40	V
MAX. dissipation	PD	400	mW
Operating temperature	Topr	-25 - 75	°C
Storage temperature	Tatg	-55 - 125	°C

ELECTRICAL SPECIFICATION ($T_a = 25^\circ\text{C}$)

	Symbol	Condition of measurement	Min.	Max.	Unit
Current vs supply Vcc	Icc	$V_{in} = 0$		4.2	mA
Voltage gain	Gvo	$f = 1\text{KHz}$, $V_{in} = -85\text{dBm}$	87		dB

EQUIVALENT CIRCUIT

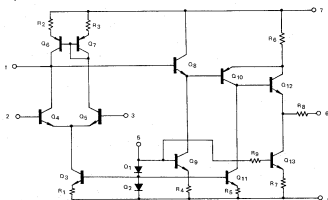

PIN CONNECTION

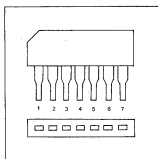

PIN CONNECTION

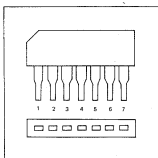

MAXIMUM LIMITS OF DEVICE ($T_a = 25^\circ\text{C}$)

	Symbol	Rating	Unit
Max supply voltage	Vcc	15	V
Output voltage	Vout	24	V
Input voltage	Vin	+3	V
Max dissipation	Pc	300	mW
Operating temperature	Topr	-30 - 75	$^\circ\text{C}$
Storage temperature	Tstg	-55 - 125	$^\circ\text{C}$

EQUIVALENT CIRCUIT

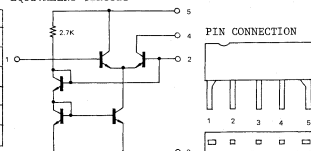
ELECTRICAL SPECIFICATION ($T_a = 25^\circ\text{C}$)

	Symbol	Condition of measurement	min	typ	max	unit
Current vs supply Vcc	Icc	Vcc = 12V (9V)	6.5	10.5 (7.0)	14.5	mA
Power dissipation	Pc	Vcc = 12V (9V)	78	126 (63)	174	mW
Voltage gain	Gv	Vcc = 12V, Rg = 50-ohm, RL = 1kohm	26	32	38	dB
Power gain	Gp	Vcc = 12V, f = 10.7MHz		30		dB
Input impedance	Rin	Vcc = 12V, f = 10.7MHz		3.8		kohm
Input capacitance	Cin			8.3		pF
Output impedance	Rout			(80)		kohm
Output capacitance	Gout			2.8		pF

PB1007 COMPONENT VIEW

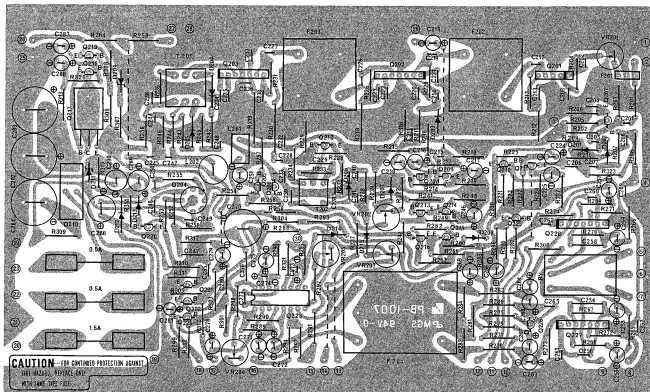

REPLACEMENT PARTS

RESISTORS: $\pm 5\%$ 1/4 watt deposited carbon, unless noted otherwise.

PB-1007

SYMBOL			LOCATION			SYMBOL			LOCATION			SYMBOL			LOCATION		
R201	2.2K	X-5	R246	6.8K	X-2	R290	3.3K	Z-3									
202	22K	X-5	247	33K	Y-4	291	220	Z-3									
203	3.3K	X-5	248	47	Y-4	292	680	Z-3									
204	4.7K	X-5	249	33K	Y-4	293	10K	Y-3									
205	4.7K	X-5	250	15K	Y-5	294	10K	Z-3									
206	820	X-5	251	680K	Y-2	295	100K	Y-3									
207	10K	X-5	252	270K	Y-2	296	3.3K	Y-3									
208	100K	X-5	253	390	Y-2	297	150	Z-3									
209	82K	X-5	254	22	Y-2	298	12K	Z-2									
210	47K	Y-5	255	1.5K	Y-2	299	4.7K	Z-2									
211	10K	X-4	256	22K	Y-3	300	22	Y-5									
212	470	X-5	257	22K	Y-3	301	120K	Z-2									
213	1K	X-5	258	100K	Y-3	302	100K	Z-2									
214	220K	Y-4	259	10K	X-2	303	47K	Z-2									
215	56K	X-4	260	15K	Y-4	304	100K	Y-3									
216	1K	X-4	261	1K	Y-4	305	33K	Z-2									
217	330K	Y-4	262	33K	Y-4	306	1K	X-1									
218	10K	Y-4	263	33K	Y-4	307	6.8K	X-1									
219	1.8K	Y-4	264	27K	X-1	308	1.5K	X-1									
220	560	X-4	265	150K	Z-5	309	330	Y-1 flame proof									
221	10K	Y-5	266	150K	Y-5	310	56K	Z-2									
222	100K	Y-5	267	33K	Z-5	311	22K	Z-2									
223	100K	Y-5	268	1.2K	Z-5	312	100K	Z-2									
224	10K	Y-5	269	1.2K	Y-5	313	4.7K	X-1									
225	22K	Y-5	270	33K	Y-5	314	22K	Y-1									
226	1K	X-3	271	82K	Y-5	315	330	Y-1									
227	100	Y-5	272	82K	Z-5	316	100K	X-4									
228	68K	Y-3	273	150K	Z-5	317	470K	Y-2									
229	12K	X-3	274	150K	Y-5	318	220	X-3									
230	1K	X-3	275	1M	Z-5	319	390	X-3									
231	560	X-3	276	100K	Y-5	320	5.6K	X-1									
232	560	Y-3	277	47K	Z-5	321	47K	Y-3									
233	15K	Y-3	278	15K	Z-5	322	47	Y-4									
234	470	Y-3	279	220K	Z-5	323	100K	Y-5									
235	100K	X-2	280	220K	Z-5												
236	1K	X-2	281	33K	Z-4												
237	100	Y-3	282	3.3K	Z-4												
238	470	Y-3	283	15K	Z-5												
239	1.8K	Y-4	284	3.3K	Z-4												
241	47K	Y-4	285	100K	Y-4												
242	1K	X-2	286	10K	Y-5												
243	1K	X-2	287	10K	Y-5												
244	47	X-2	288	150	Y-3 flame proof												
245	6.8K	X-2	289	3.3K	Z-3												
C201	470pF	+10%	50V	ceramic	X-5	C223	0.04uF	+80%	-20%	25V	ceramic	X-4					
202	0.01uF	+80%	-20%	25V	ceramic	X-5	224	1 uF	+75%	-10%	25V	electrolytic	Y-5				
203	0.04uF	+80%	-20%	25V	ceramic	X-5	225	4.7uF	+75%	-10%	25V	"	Y-5				
204	0.04uF	+80%	-20%	25V	ceramic	X-5	226	0.01uF	+80%	-20%	25V	ceramic	X-3				
205	470pF	+10%	-10%	50V	"	X-5	227	0.01uF	+80%	-20%	25V	"	X-3				
206	0.04uF	+80%	-20%	25V	"	Y-5	228	470pF	+10%	-10%	50V	"	Y-3				
207	0.01uF	+80%	-20%	25V	"	Y-5	229	0.47pF	+5%	-5%	500V	small molded	Y-3				
208	0.01uF	+80%	-20%	25V	"	X-5	230	0.04uF	+80%	-20%	25V	ceramic	X-3				
209	0.04uF	+80%	-20%	25V	"	Y-5	231	0.04uF	+80%	-20%	25V	ceramic	Y-3				
210	0.47uF	+75%	-10%	25V	electrolytic	Y-4	232	0.04uF	+80%	-20%	25V	"	X-3				
211	0.01uF	+80%	-20%	25V	ceramic	X-4	233	0.04uF	+80%	-20%	25V	"	Y-3				
212	0.01uF	+80%	-20%	25V	"	X-5	234	0.04uF	+80%	-20%	25V	"	X-2				
213	0.04uF	+80%	-20%	25V	"	X-5	235	0.04uF	+80%	-20%	25V	"	X-2				
214	470pF	+10%	-10%	50V	"	X-4	236	0.04uF	+80%	-20%	25V	"	X-2				
215	470pF	+10%	-10%	50V	"	Y-4	237	0.04uF	+80%	-20%	25V	"	X-3				
216	4.7uF	+75%	-10%	25V	electrolytic	Y-4	238	0.04uF	+80%	-20%	25V	"	X-2				
217	33uF	+75%	-10%	16V	"	Y-4	239	0.04uF	+80%	-20%	25V	"	Y-3				
218	0.47uF	+75%	-10%	25V	"	X-4	240	0.01uF	+80%	-20%	25V	"	Y-3				
219	0.01uF	+80%	-20%	25V	ceramic	X-4	241	0.01uF	+80%	-20%	25V	"	Y-3				
220	0.04uF	+80%	-20%	25V	"	X-4	242	470pF	+10%	-10%	50V	"	Y-2				
221	0.04uF	+80%	-20%	25V	"	X-4	243	470pF	+10%	-10%	50V	"	X-2				
222	0.04uF	+80%	-20%	25V	"	X-4	244	470pF	+10%	-10%	50V	"	X-2				

SYMBOL				SYMBOL									
C245	100pF	+10%	-10%	50V	ceramic	Y-2	C268	2.2uF	+75%	-10%	25V	electrolytic	Z-5
246	0.47uF	+75%	-10%	25V	electrolytic	Y-4	269	10uF	+75%	-10%	16V	"	Z-4
247	0.12uF	+10%	-10%	50V	mylar	Y-2	270	330uF	+75%	-10%	16V	"	Y-2
248	0.02uF	+80%	-20%	25V	ceramic	Y-2	271	4.7uF	+75%	-10%	25V	"	Z-3
249	220pF	+10%	-10%	50V	"	Y-2	272	4.7uF	+75%	-10%	25V	"	Z-3
250	0.0047uF	+20%	-20%	50V	"	Y-2	273	0.33uF	+20%	-20%	35Vsolid	tantalum	Z-3
251	2.2uF	+75%	-10%	25V	electrolytic	Y-2	274	0.22uF	+20%	-20%	35V	"	Z-3
252	0.04uF	+80%	-20%	25V	ceramic	Z-5	275	0.47uF	+75%	-10%	25V	electrolytic	Y-3
253	2.2uF	+75%	-10%	25V	electrolytic	Z-5	276	1000pF	+5%	-5%	50V	polystyrol	Z-2
254	750pF	+5%	-5%	50V	polystyrol	Z-5	277	0.04uF	+80%	-20%	25V	ceramic	Z-2
255	10uF	+75%	-10%	16V	electrolytic	Z-5	278	10uF	+75%	-10%	16V	electrolytic	Z-2
256	47pF	+10%	-10%	50V	ceramic	Z-5	279	2.2uF	+75%	-10%	25V	"	Y-2
257	10uF	+75%	-10%	16V	electrolytic	Y-5	280	100pF	+5%	-5%	50V	polystyrol	Z-2
258	750pF	+5%	-5%	50V	polystyrol	Y-5	281	0.47uF	+75%	-10%	25V	electrolytic	Z-2
259	2.2uF	+75%	-10%	25V	electrolytic	Y-5	282	1000uF	+75%	-10%	25V	"	Y-1
260	47pF	+10%	-10%	50V	ceramic	Y-5	283	1000uF	+75%	-10%	25V	"	X-1
261	47pF	+10%	-10%	50V	"	Z-5	284	1000uF	+75%	-10%	25V	"	Y-1
262	47pF	+10%	-10%	50V	"	Y-5	285	0.04uF	+80%	-20%	25V	ceramic	Z-2
263	2.2uF	+75%	-10%	25V	electrolytic	Z-5	286	100uF	+75%	-10%	16V	electrolytic	Y-1
264	2.2uF	+75%	-10%	25V	"	Z-5	287	10uF	+75%	-10%	16V	"	X-1
265	0.01uF	+80%	-20%	25V	ceramic	Z-5	288	10uF	+75%	-10%	16V	"	X-1
266	1 uF	+75%	-20%	25V	electrolytic	Z-5	289	47uF	+75%	-10%	16V	"	Y-2
267	2.2uF	+75%	-20%	25V	"	Z-5	290	47uF	+75%	-10%	16V	"	Y-1
VR201	470 ohm	B	X-5				Q201	BA401			X-5		
202	470 ohm	B	Y-4				202	uPC 577H			X-4		
203	4.7 Kohm	B	Y-4				203	TA7061AP			X-2		
204	4.7 Kohm	B	Z-2				204	CUA709C			Y-2		
205	470 ohm	B	Y-3				205	28C1647R			Y-3		
							206	28C1647R			Y-3		
							207	28C1647L			X-5		
D201	1K188FM-1		X-5				208	28C1647R			Y-4		
202	1K188FM-1		X-5				209	28C1647R			Y-4		
203	1K188FM-1		X-4				210	28C1641R			Y-5		
204	1K188FM-1		X-2				211	28C735Y			Y-5		
205	1K188FM-1		X-2				212	28C1674L			X-3		
206	1S1554V		Y-3				213	28C1647R			Y-4		
207	KB-265		Y-4				214	28C1647R			Y-4		
208	1S1554V		Y-4				215	28C1647R			Y-4		
209	WZ-071		X-1				216	28C1647R			Y-4		
210	1SRBA10		Y-1				217	28D235 O, Y			X-1		
211	WZ-120		Y-1				218	28C1641R			X-1		
212	1S1554V		Y-1				219	28C1641R			X-1		
213	1S1554V		Y-2				220	28A823R			Y-2		
214	1S1554V		Y-3				221	28C1641R			Z-2		
215	1K188FM-1		Y-3				222	28C1641R			Z-2		
							223	28C1647R			Z-2		
F201	CFSA-30A0-10		X-5				224	LA3350SS			Z-3		
202	LUX-1060		X-4				225	28C1647R			Y-5		
203	LUX-1060		X-3				226	28K30A-0			Z-5		
204	LUX-1059		Z-4				227	TA7136P			Z-5		
							228	TA7136P			Y-5		
T201	V4FCC20693BCV		X-2										
T202	TKAC-14733K		Y-3										
L201	144LZ180K		X-2										
L202	1039		Y-2										
RY	RL-6442-R101		Z-5										
(1)		X-5	(11)			Z-5	(21)				Z-1		
(2)		X-5	(12)			Z-4	(22)				Z-1		
(3)		X-5	(13)			Z-3	(23)				Z-1		
(4)		Y-5	(14)			Z-3	(24)				Y-1		
(5)		Y-5	(15)			Z-3	(25)				X-1		
(6)		Z-5	(16)			Z-3	(26)				X-1		
(7)		Z-5	(17)			Z-2	(27)				X-2		
(8)		Z-5	(18)			Z-2	(28)				X-2		
(9)		Z-5	(19)			Z-2	(29)				X-4		
(10)		Z-5	(20)			Z-1	(30)				Y-3		

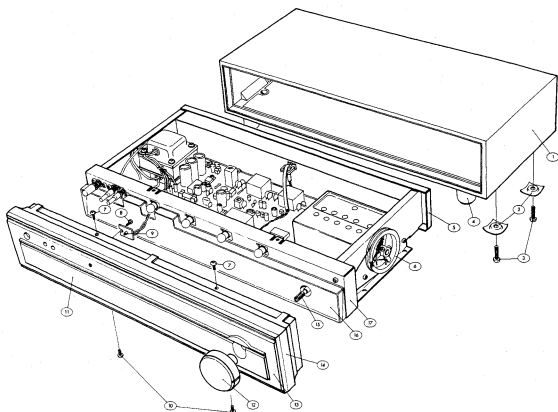

DIAL STRING DIAGRAM

1. Wooden Case
2. Square Tooth Washer
3. Screw 4mm x 16mm
4. Legs
5. Back Panel
6. Dial Drum
7. Screw 3mm x 6mm
8. Screw 3mm x 6mm
9. Stereo Indicator
10. Screw 3mm x 6mm
11. Front Panel Escutcheon
12. Tuning Knob
13. Front Panel
14. Metter Ass'y Protector (Acryl)
15. Tuning Shaft and Flywheel Ass'y
16. Meter Ass'y
17. Sub Panel
18. Guide Pulley
19. Tuning Pointer
20. Dial Cord (0.5)
21. Flywheel
22. Tension Spring

